

Note . The numbers inside the parenthesis aren't there to indicate any quantity . They indicate the part Number you should use.

Nota . Los numeros en paréntesis no es indicativo de cantidad . El numero indica el tipo de pieza que debe utilizar.

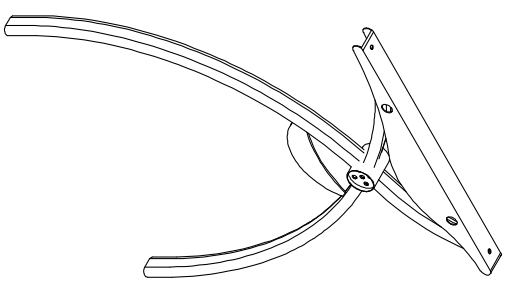

**A x 1**

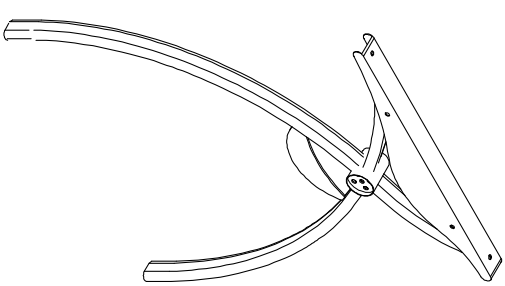

**B x 1**

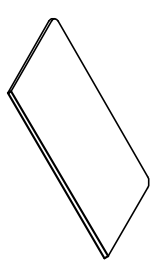

W600xD300mm  
**C x 1**

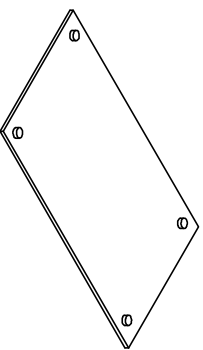

W1100xD570mm  
**D x 1**

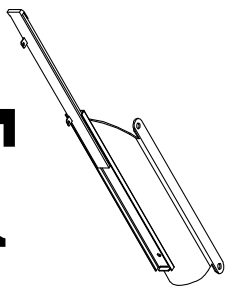

**E x 1**

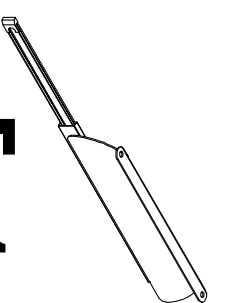

**F x 1**

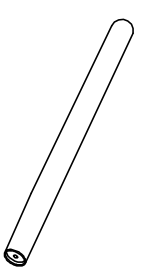

∅50\*955mm  
**G x 1**



∅19\*1065mm  
**H x 2**

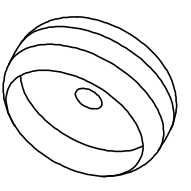

**1 x 2**

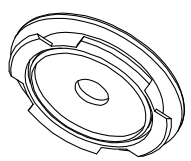

**2 x 2**

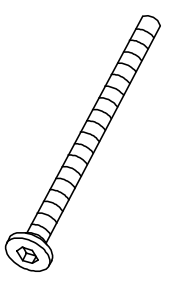

80mm  
**3 x 2**



25mm  
**4 x 8**

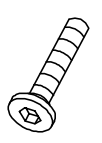

9mm  
**5 x 4**



12mm  
**6 x 4**



**7 x 2**

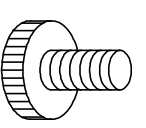

**8 x 4**

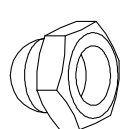

**9 x 4**

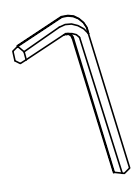

5mm  
**10 x 1**



4mm  
**11 x 1**

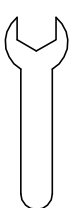

**12 x 1**

**1**

Fix the Studs (9) to the legs of the Structures (A and B)

Enrosque los Topes (9) en las patas de las Estructuras A Y B.

**4x**

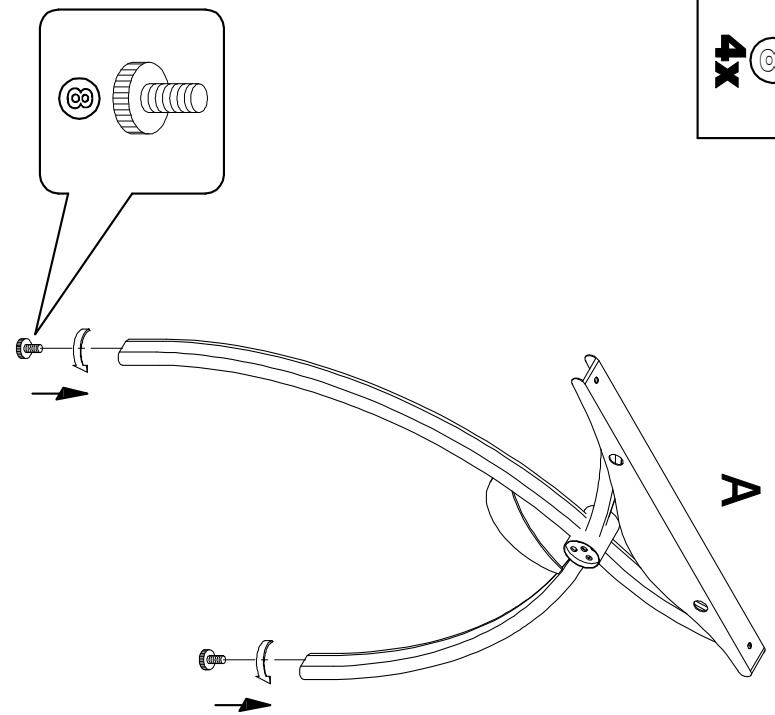

**A**

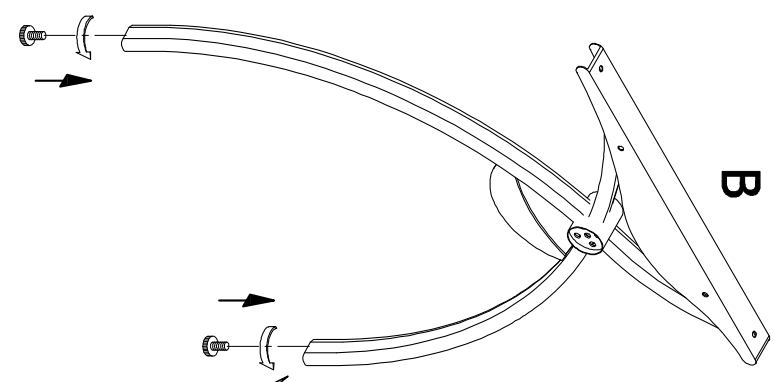

**B**

**2**

Insert and press the Parts (1) on their place on the inside face of the Structures A and B.

Inserte y presione las Tapas (1) en su lugar en la cara interna de las Estructuras A Y B.

**2x**

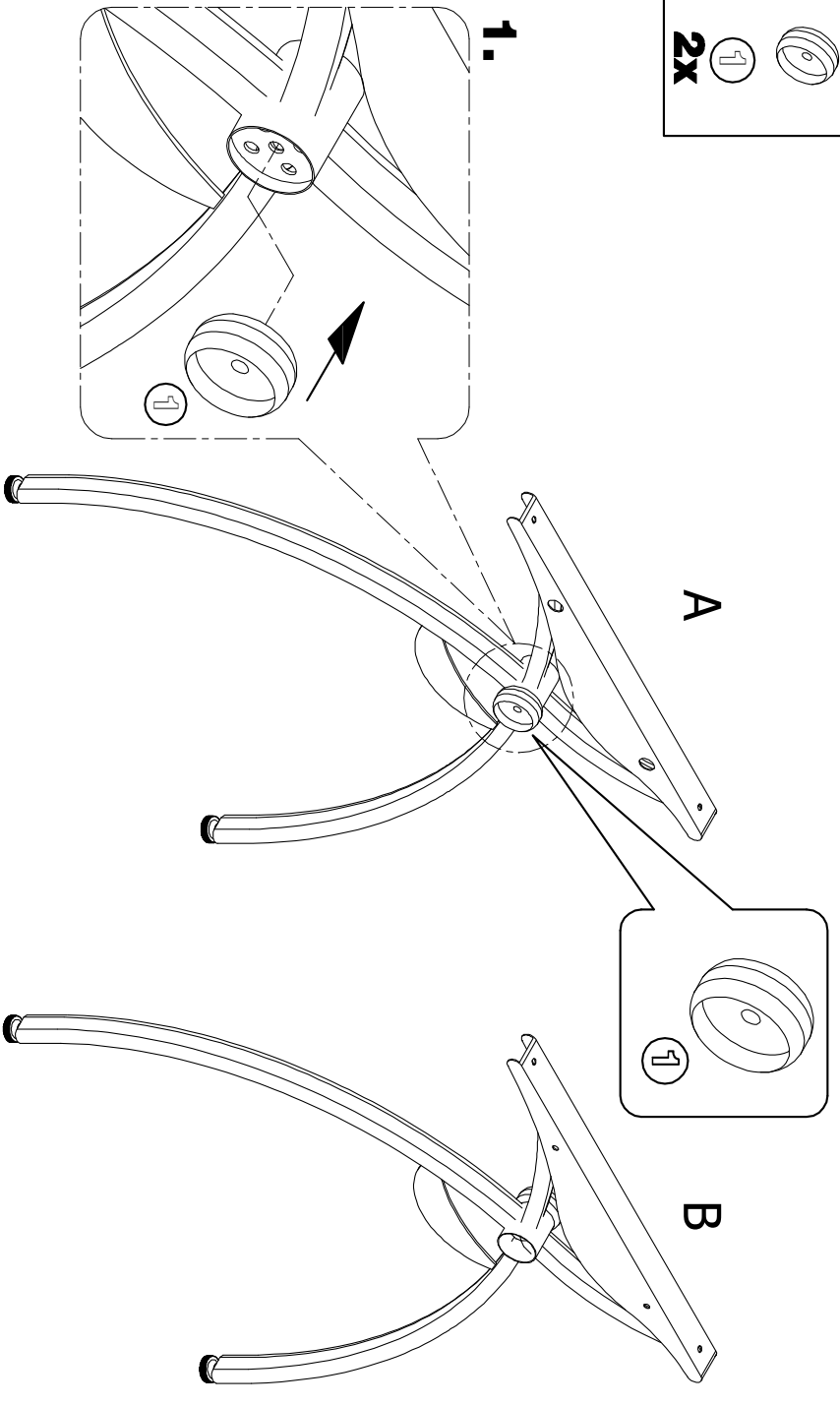

**A**

**B**

**1.**

**3**

Assemble the Tube G with the Structure A.

Ensamble el Tubo (G) a la Estructura A.

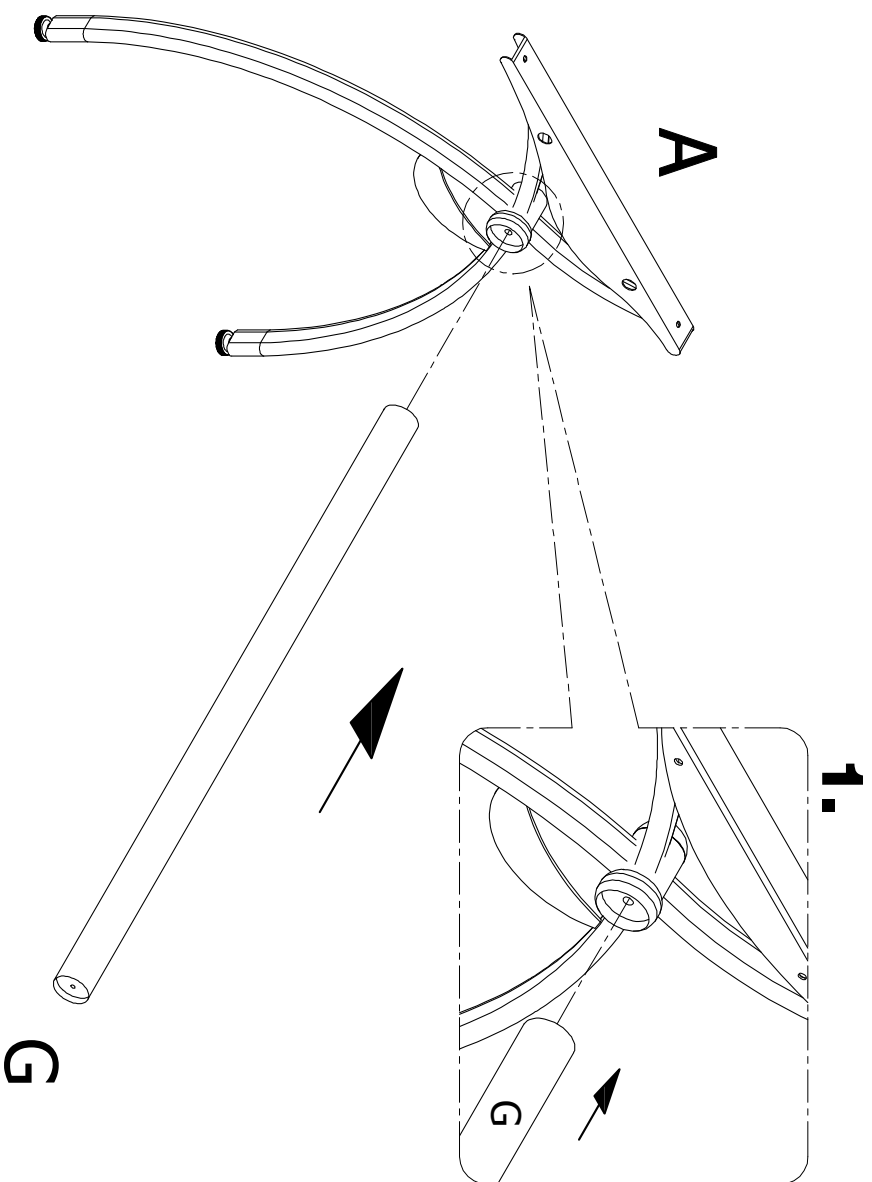
**4**

Insert the Tubes (H) on the Holes of the Structure A and fix them with Screws (4). Then fix the Tube G using a screw (3) and a Washer (7).

Inserte los Tubos (H) en los huecos dispuestos para ellos en la Estructura A y fíjelos usando Tornillos (4). También fije el Tubo (G) con Tornillo (3) y Arandela (7).

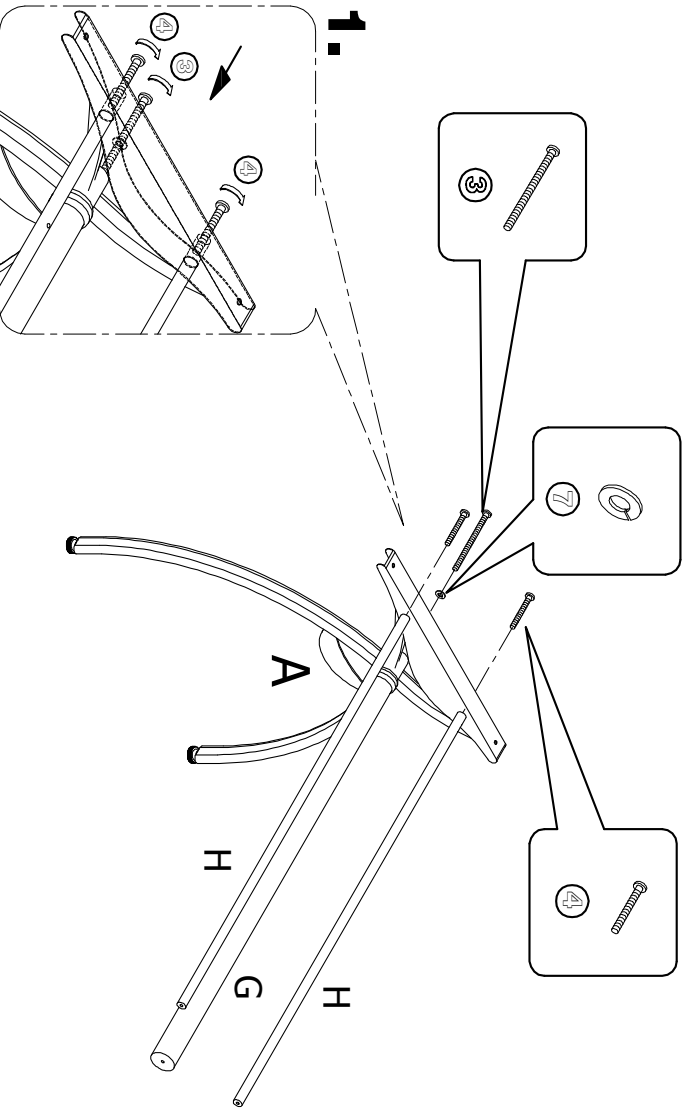
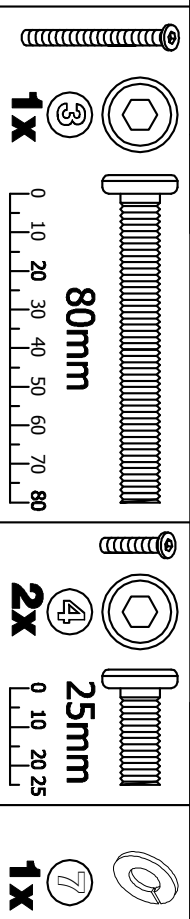
**5**

Fix the Structure B to the already assembled part using Screws (4) and a set of Screw (3) and Washer (7).

Ensamble la Estructura B con la parte del mueble que tiene armada hasta ahora y fíjelas con Tornillos (4) y Tornillo (3) que lleva una Arandela (7).

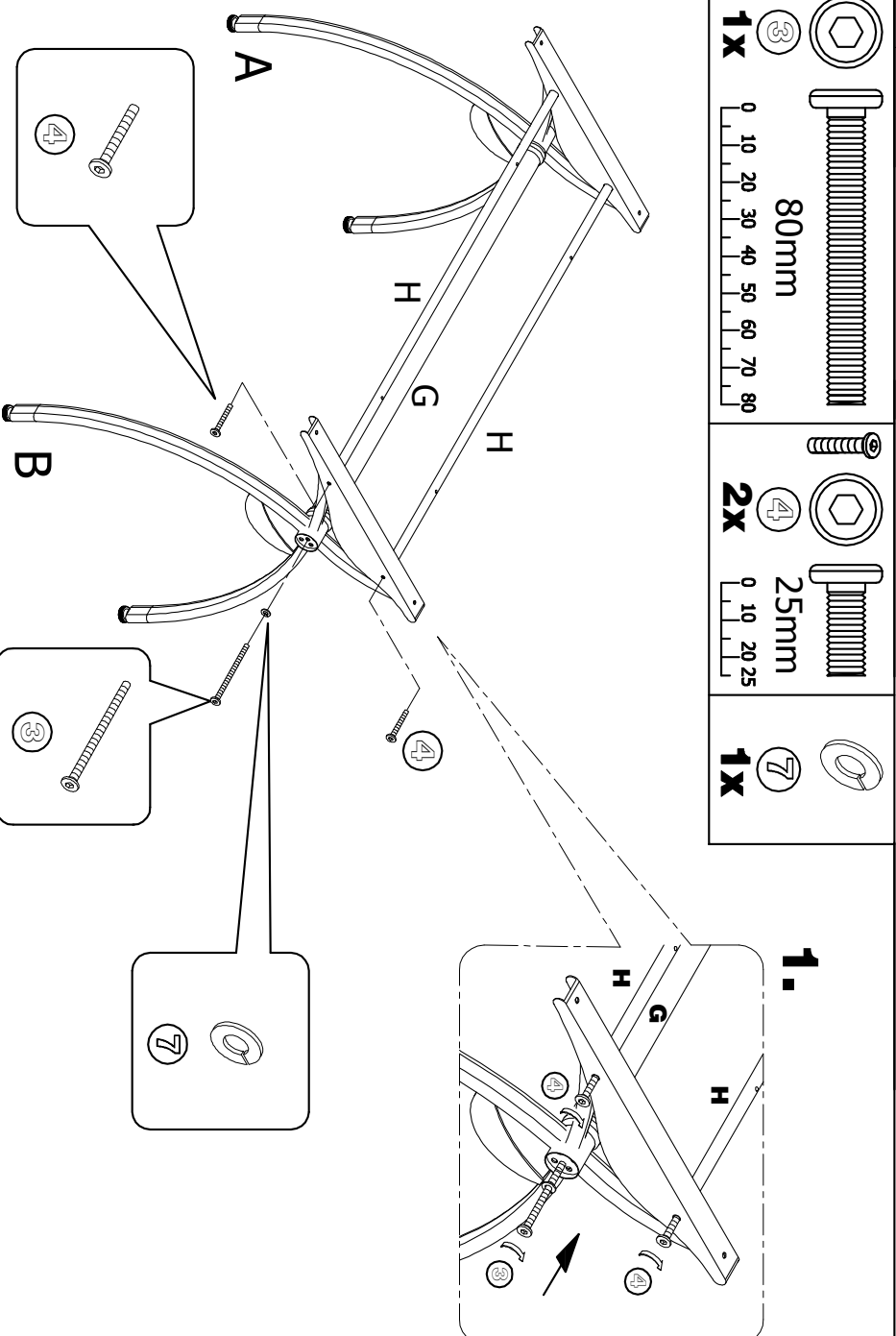
**6**

Insert and Press the Parts (2) on the outside of the Structures A and B.

Inserte a presión (debe entrar muy bien) las piezas (2) en los espacios dispuestos para estas en las Estructuras (A Y B).

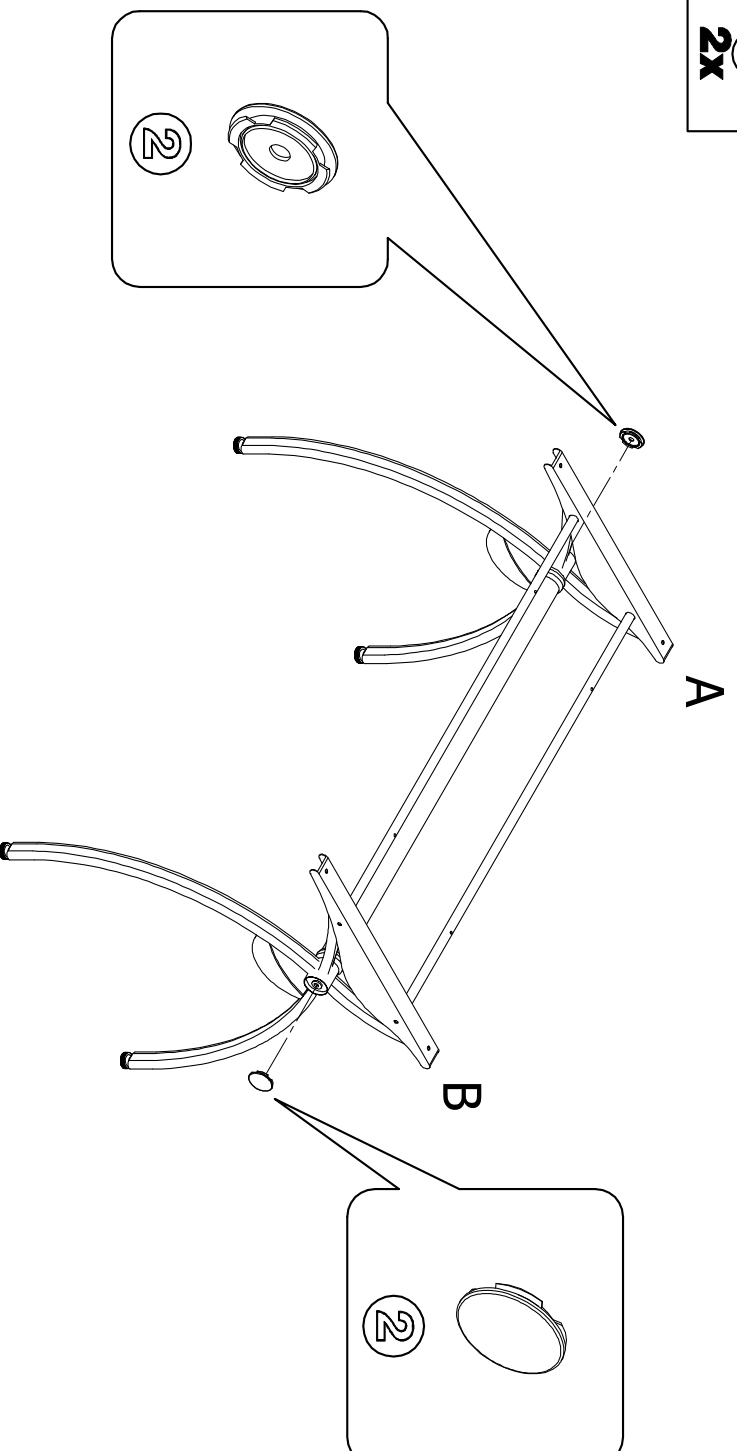



Use Screws (4) and Nuts (9) to Fix the sliders (E and F) to the Tubes (H). Note that the sliders , should slide out to the front of the desk.  
 Tome los deslizadores (E y F) y fíjelos a los Tubos (H) , usando Tornillos (4) y Tuercas (9). Fíjese que los deslizadores salgan hacia delante.

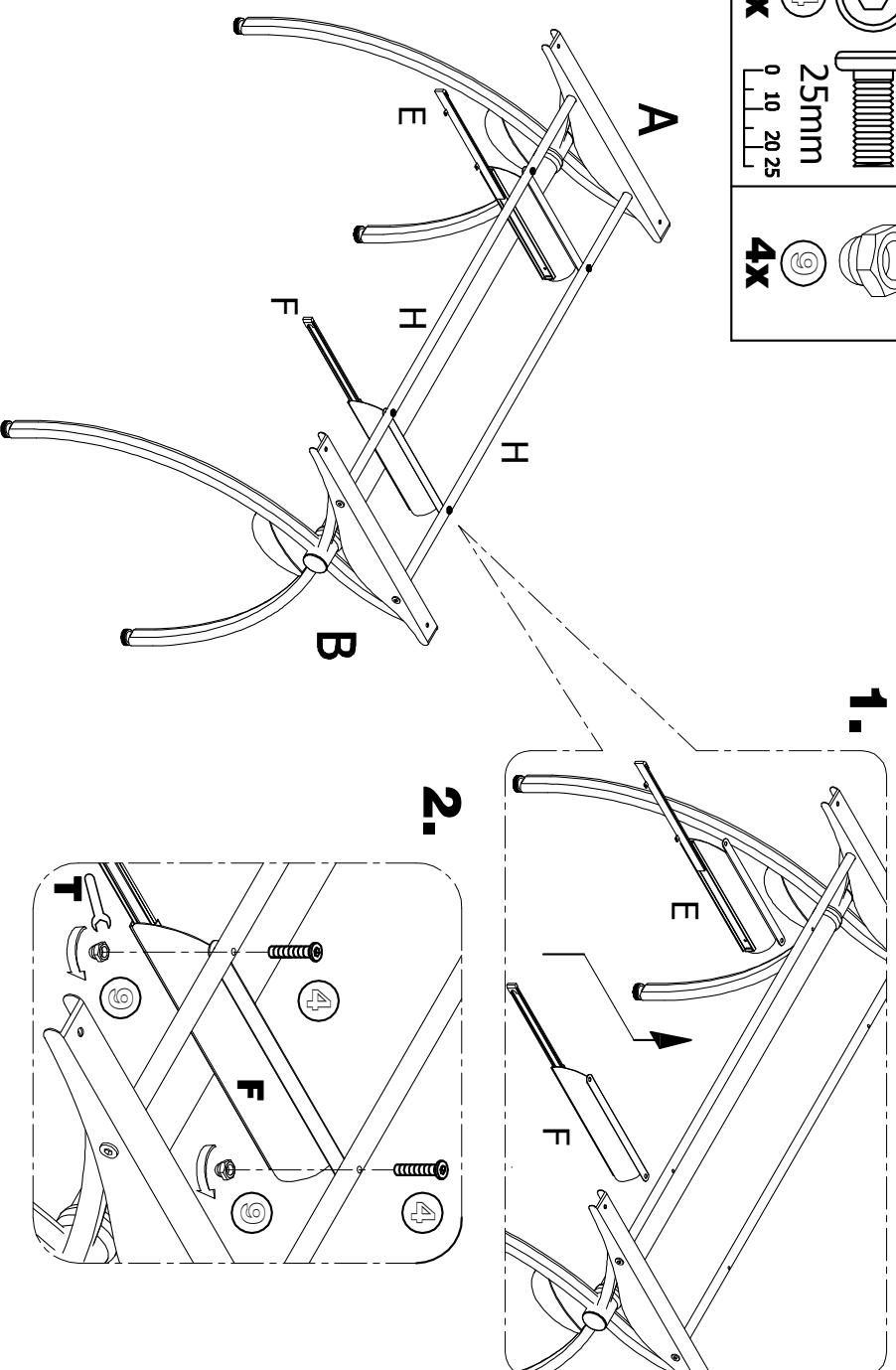
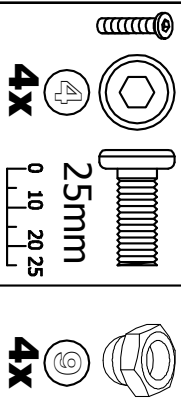

Place the Keyboard Panel (C) over the sliders (E and F) , and fix them from below with Screws (6).  
 Coloque el Panel de Teclado (C) sobre los rieles de los Deslizadores (E y F) y desde abajo sobre la cara posterior , fíjelos con Tornillos (6)

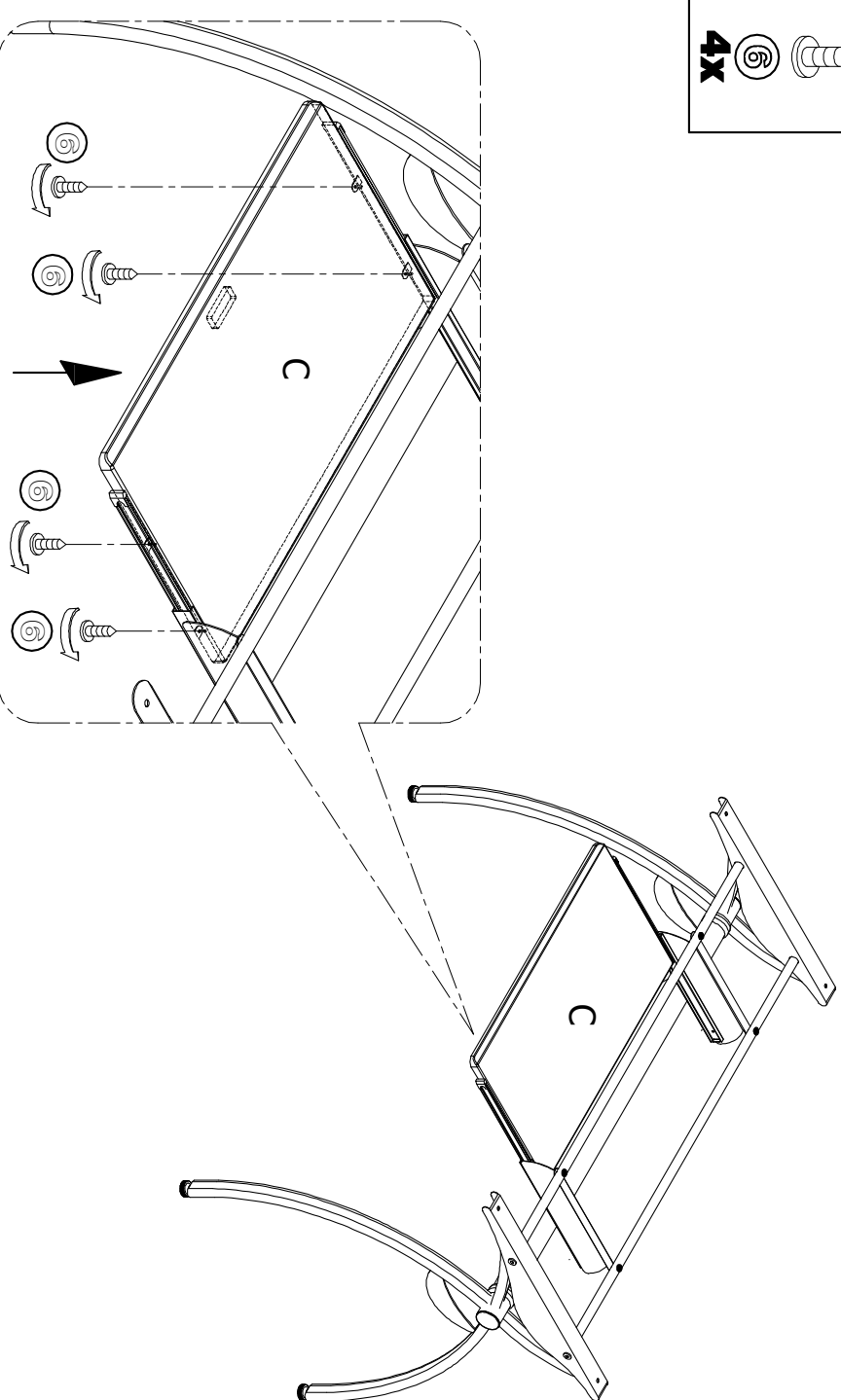
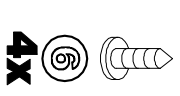

Place the Glass Panels D over the structures A and B and fix them with screws (5) Dont tight the screws until the glass panel fits in it's correct place.  
 Coloque el Vidrio Principal (D) sobre las Estructuras (A y B) haciendo coincidir los huecos y asegúrelo desde abajo con Tornillos (5). Ojo no ajuste los tornillos apenas los coloque, sino que vaya ajustando un poco cada uno para que no se descuadre el vidrio.

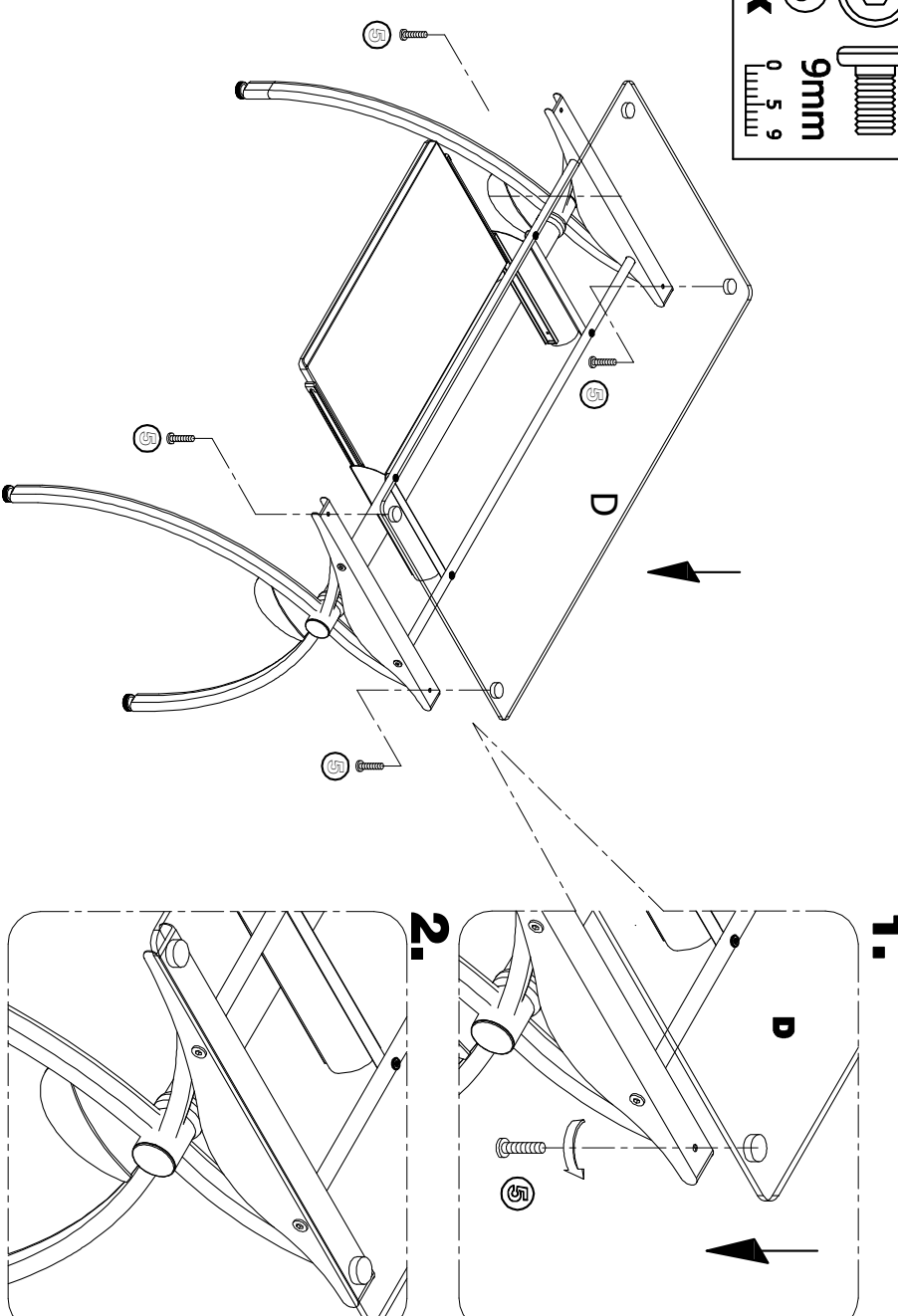
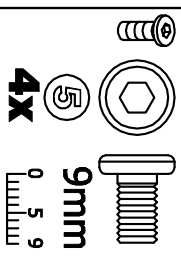

Tight well all the screws and enjoy this magnificent desk.  
 Ajuste bien todos los Tornillos y disfrute este único escritorio.

